

E21268

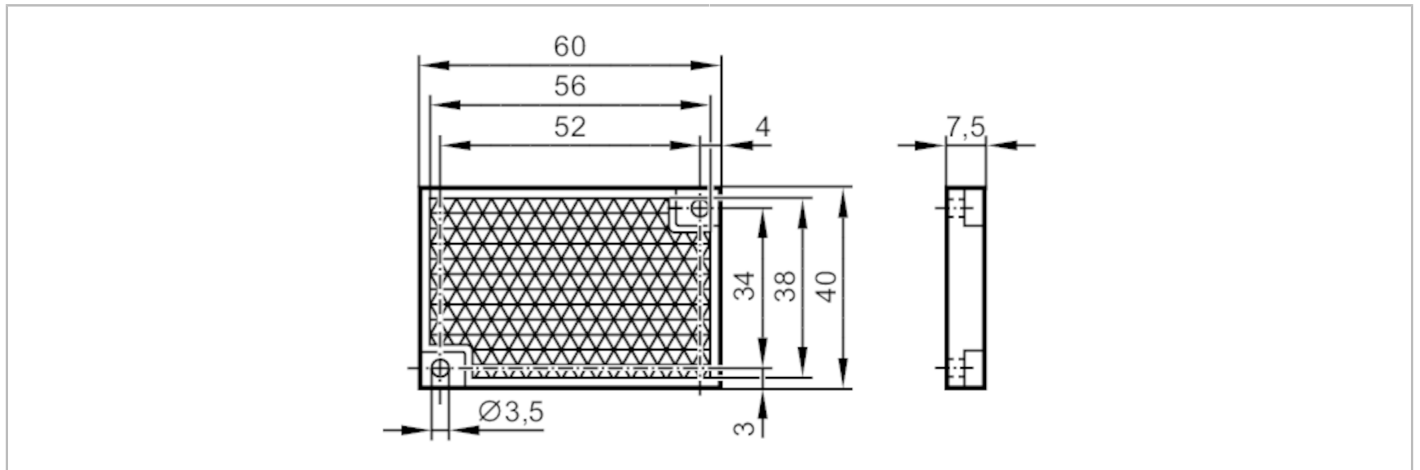

Reflector for retro-reflective sensors

REFLECTOR TS-56X38 SC



Application

Design

for hygienic and wet areas in the food industry, rectangular,
for red light and infrared light retro-reflective sensors

Operating conditions

Ambient temperature

[°C]

-20...140

Mechanical data

Weight

[g]

14.6

Dimensions

[mm]

40 x 60 x 7.5

Reflector surface

[mm]

56 x 38

Materials

Solidchem

Remarks

Pack quantity

1 pcs.